

COMPLETED BY: _____
DATE: _____



THERMO PRODUCTS, LLC
PO BOX 237
DENTON, NC 27239
techservice@thermopride.com
PHONE# 800-476-4328
FAX# 336-859-3622

FOR OFFICE USE ONLY
APPROVED BY: _____
DATE: _____

INSPECTION REPORT FOR WARRANTED HEAT EXCHANGER

NOTICE: IF THE FOLLOWING INFORMATION IS NOT COMPLETE AND ACCURATE, THIS WARRANTY CLAIM MAY BE DELAYED OR DENIED.

IMPORTANT: *All replacement Heat Exchangers requested for shipment prior to confirmation of the warranty claim approval will be billed to the ordering dealer. If the claim is denied, the dealer will be responsible for the Heat Exchanger and shipping cost.*

Service company _____ *Billing address* _____

City _____ State _____ Zip _____ Phone _____

Contact person for questions. _____

Check box if *shipping address* same as *Billing address* above. (If same skip next section)

Destination company _____ *Shipping address* _____

City _____ State _____ Zip _____ Phone _____

IMPORTANT: *User or Owner is responsible for cost of freight.*

User/Owner name _____ Address _____

City _____ State _____ Zip _____ Phone _____

Is this the original purchaser of the unit? Yes No

Furnace Model no. _____ (front or rear flue) please circle one.

Serial no. _____ Date installed _____ Date failed _____



PERFORMANCE DATA

Temperature rise _____ (Supply air temp - (minus) Return air temp=Temp rise)

Nozzle size, Orifice size or Rate _____ Fuel type _____

Tonnage of A/C on unit _____ o check box if no A/C on furnace

WARRANTY INFORMATION

1. Is this unit installed according to local and state codes regarding safety and electrical wiring requirements and/or the installation instructions furnished by Thermo Products Inc? o Yes o No
2. Have the limit controls been modified, bypassed or altered? o Yes o No
3. Is this unit installed in a corrosive atmosphere such as a dry cleaner, beauty parlor, laundromat or industrial environment? o Yes o No
4. Is there an air conditioning coil or heat pump coil on the return air side of the furnace? o Yes o No
5. Is this failue due to water/condensate damage or act of God? o Yes o No
6. Was this unit modified and/or operated in any manner other than its design configuration? o Yes o No

Is a replacement combustion chamber required? o Yes o No
(The Heat Exchanger is the only component covered under the lifetime warranty)

Please check one below:

- Replacement Heat Exchanger required? o
- Allowance toward a new Thermo Pride unit? o
(If available, provide invoice No. _____)
- Credit for Heat Exchanger already purchased? o
(If available, provide invoice No. _____)

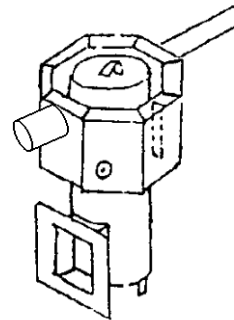

NOTICE:
IF HEAT EXCHANGER STYLE IS NOT OIL OR GAS OCTAGON CALL FOR PAGE THREE

INDICATE FAILURE ↑ LOCATION ABOVE

DESSCRIPTION OF FAILURE

DATE _____ SIGNED _____

MARK APPROPRIATE DIAGRAM WITH LOCATION OF HEAT EXCHANGER FAILURE.

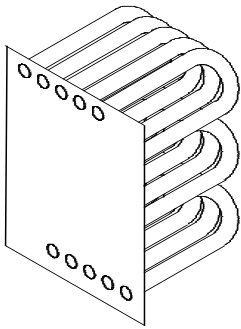

MHA & MDA,
GMD, GPA

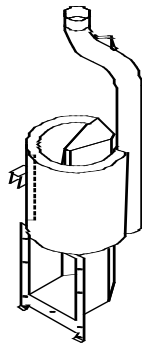

OMA & GMA

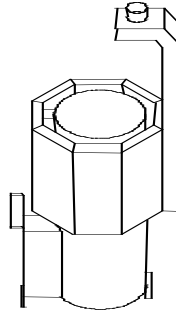

OC1,GC1,
OMC, OME

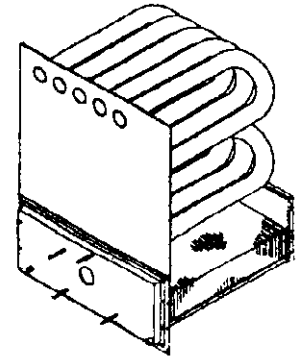

CHA,CHB,CCA,CCB,CDB,
CLH, CLO

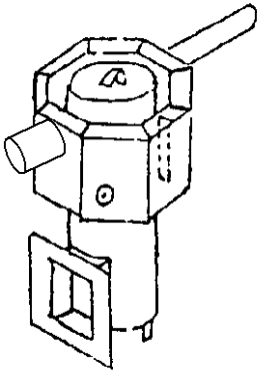

OCTAGON GAS or OIL

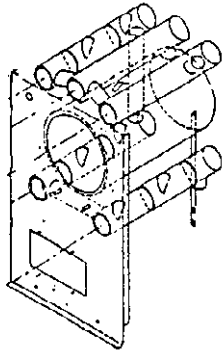

GHC

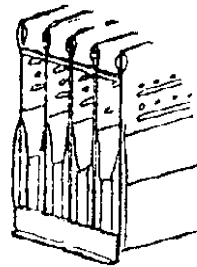

SECTIONAL GAS GH,GL,GC or IGH & IGC

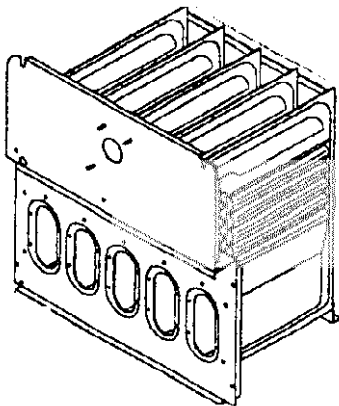
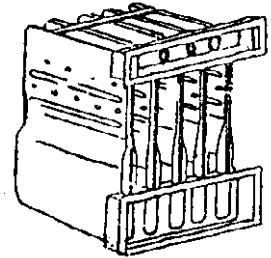

IHB & IHA

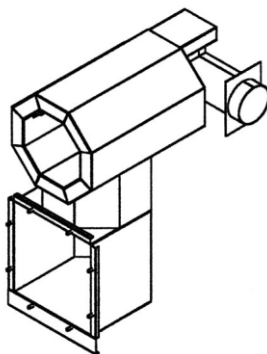

OPA

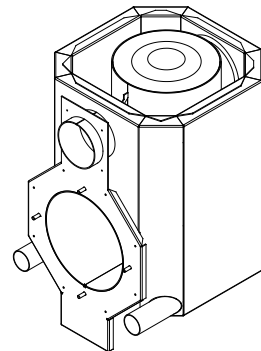

OH6, OH8, OL6, OD6

SERVICE COMPANY _____

DATE _____ SIGNED _____